



DICOM Conformance Statement

Document Version
2.0

Revision Summary

Date	Revision	Changes
30 th December 2016	2.0	Update to OrthoView 7.0 Specification
20 October 2005	1.0	Release of OrthoView 3.1 WK3 build

Contents

Revision Summary	2
Contents	3
Introduction	5
Scope and Field of application.....	5
Intended Audience	5
Contents and Structure	5
Used Definitions, terms and abbreviations	5
References	5
Important Note to the Reader.....	5
Interoperability.....	5
Validation.....	6
New Versions of the DICOM standard.....	6
General Acronyms and abbreviations	6
Implementation Model.....	7
Application Data Flow Diagrams	10
Verify a Remote System SCU	10
Query/Retrieve SCU	11
Store SCU	11
Functional Definition of Application Entities.....	12
Sequencing of Real World Activities	12
Network Service Specifications	12
Association Establishment Policies	13
Number of Associations.....	13
Asynchronous Nature.....	13
Implementation Identifying Information	13
Association Initiation Policy.....	13
Verification C-ECHO	13
Associated Real World Activity	14
Proposed Presentation Contexts.....	14
Query/Retrieve Composite C-FIND, C-MOVE and C-GET	14
Associated Real World Activity	14
Proposed Presentation Contexts.....	14
Implementation Model.....	15
C-Store as an SCP	15
Associated Real World Activity	16
Proposed Presentation Contexts.....	16
Implementation Model.....	16
C-Store as an SCU	17
Associated Real World Activity	17
Proposed Presentation Contexts.....	17
Implementation Model.....	18
Communication Profiles	18
Supported Communication Stacks.....	18

TCP/IP Stack.....	18
Physical Media Support	18
Extensions/Specializations/Privatizations.....	18
Configuration	18
Remote Connections	18
Incoming Settings (where incoming supported).....	19
Query Settings (where query-retrieve supported).....	19
Outgoing Settings.....	20
Support of Extended Character Sets	20

Introduction

This document specifies the DICOM 3.0 conformance statement of the DICOM Services provided by OrthoView 7.0.

OrthoView is digital planning software used by surgeons for planning their surgery.

Scope and Field of application

The scope of this DICOM Conformance statement is to enable data exchange to take place between OrthoView and other DICOM devices.

Intended Audience

This conformance statement is intended for:-

- (Potential) Customers
- System Integrators of Medical Equipment
- Marketing Staff interested in the system functionality
- Software designers implementing DICOM interfaces

It is assumed that the reader has understanding of the DICOM standard.

Contents and Structure

This document conforms to the standards specified in the Digital Imaging and Communications in Medicine (DICOM) standards defined by NEMA Standard Publications PS 3.2-2011 and Supplements.

Used Definitions, terms and abbreviations

Definitions, terms and abbreviations used in this document are defined within the different parts of the DICOM standard. For a description of these see NEMA PS 3.3-2011 and PS3.4-2011.

References

Digital Imaging and Communication in Medicine (DICOM) standard, NEMA PS 3.x.

Important Note to the Reader

DICOM does not guarantee interoperability and this conformance statement is only the first stage of validating such connectivity.

Interoperability

The integration of devices into a networked environment may require application functions outside the scope of the DICOM standard. The DICOM interoperability stated here does not therefore imply interoperability with any other equipment. It is the users' responsibility to specify a solution which correctly integrates this product with other equipment.

Validation

When linking this product with other equipment, the first step is to compare the relevant Conformance Statements. If the Conformance Statements indicate that successful information exchange should be possible, additional validation tests will be necessary to ensure functionality, performance, accuracy and the stability of such a connection. It is the responsibility of the user to specify the appropriate test suite and to carry out the additional validation tests to prove the connectivity.

New Versions of the DICOM standard

New versions of the DICOM standard are likely to be produced to meet the changing needs of the medical industry. Such changes may invalidate the conformances contained in this document and lead to difficulties in connecting to devices developed under a different standard.

General Acronyms and abbreviations

Definitions, terms and abbreviations used in this document are defined within the different parts of the

DICOM standard and the IHE framework.

- ACR American College of Radiology
- AE Application Entity
- AET Application Entity Title
- ASCII American Standard Code for Information Interchange
- DB Database
- DICOM Digital Imaging and Communications in Medicine
- DIMSE DICOM Message Service Element
- DIMSE-C DICOM Message Service Element-Composite
- DIMSE-N DICOM Message Service Element-Normative
- GUI Graphical User Interface
- IOD Information Object Definition

- ISO International Standard Organization
- NEMA National Electrical Manufacturers Association
- OSI Open Systems Interconnection
- PACS Picture Archive & Communication System
- PDU Protocol Data Unit
- RGB Reg Green Blue
- ROI Region of Interest
- SCU Service Class User (DICOM client)
- SCP Service Class Provider (DICOM server)
- SOP Service-Object Pair
- Tag A 32 bit integer consisting of a group/element pair
- TCP/IP Transmission Control Protocol/Internet Protocol
- UID Unique Identifier Attribute
- VR Value Representation
- VM Value Multiplicity

Implementation Model

OrthoView is a standalone executable but it may be launched from an integrating host such as a PACS Viewer. Typically when launched from a viewer it will be passed DICOM files in a folder or given a reference to the images such that they can be retrieved from a PACS archive via DICOM connectivity.

OrthoView can be installed on current Windows and MAC OS X Operating Systems.

The set of DICOM features available to any particular installation of OrthoView is controlled via configuration. The code is always the same. Typical installations would be:-

- 1) An integrating PACS Viewer passes DICOM files to OrthoView in a folder and OrthoView generates output DICOM files and puts them into the same folder for the Viewer to send them back to a PACS System. This requires NO DICOM connectivity from OrthoView simply the ability to read and write DICOM files.

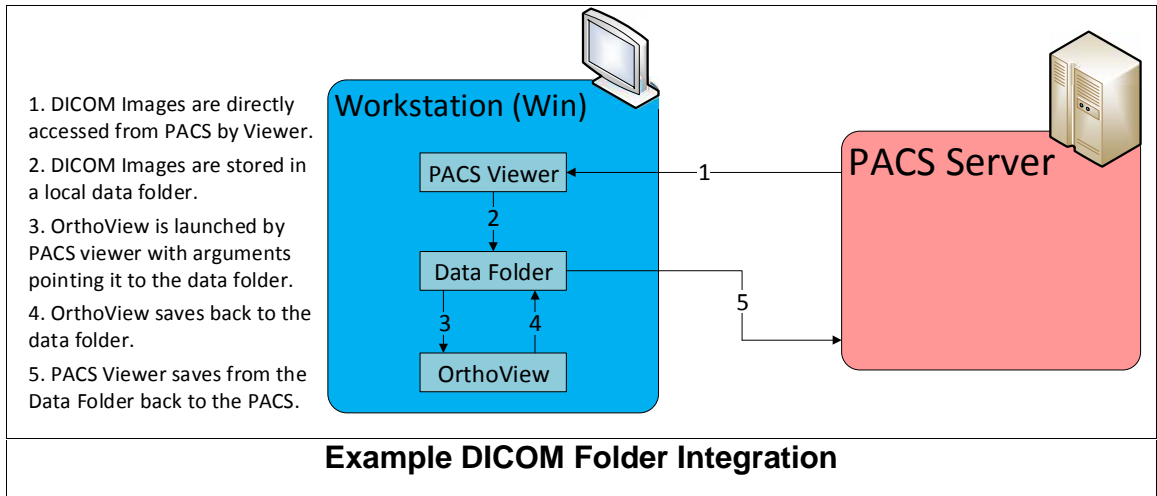

- 2) An Integrating PACS Viewer passes DICOM files to OrthoView in a folder and OrthoView generates output DICOM files and sends them direct to a PACS archive via a C-STORE command (C-Store as an SCU).

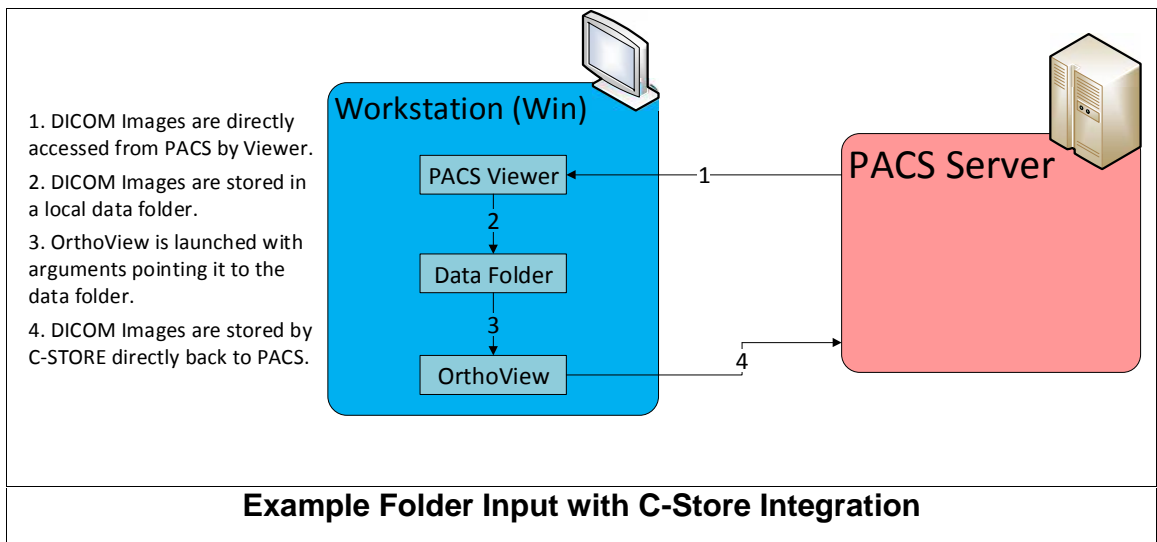

- 3) An integrating PACS Viewer passes a reference to a set of DICOM files via a suitable DICOM reference (e.g. Study UID, Accession Number) which OrthoView then uses to query the archive using C-FIND and retrieve using C-MOVE or C-GET. OrthoView then generates DICOM output files which can be sent back to the PACS archive via a C-STORE command (C-Store as an SCU).

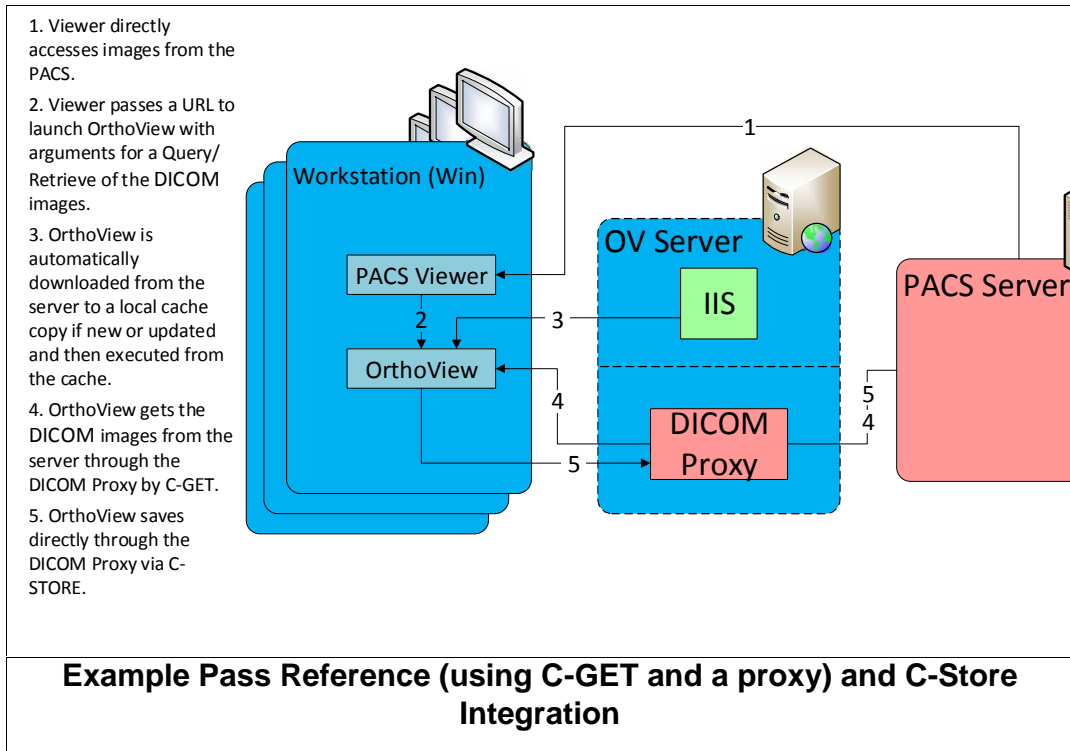

- 4) A Standalone OrthoView uses a query-retrieve GUI to identify the studies and download them and uses C-Store to store its output back to the archive.

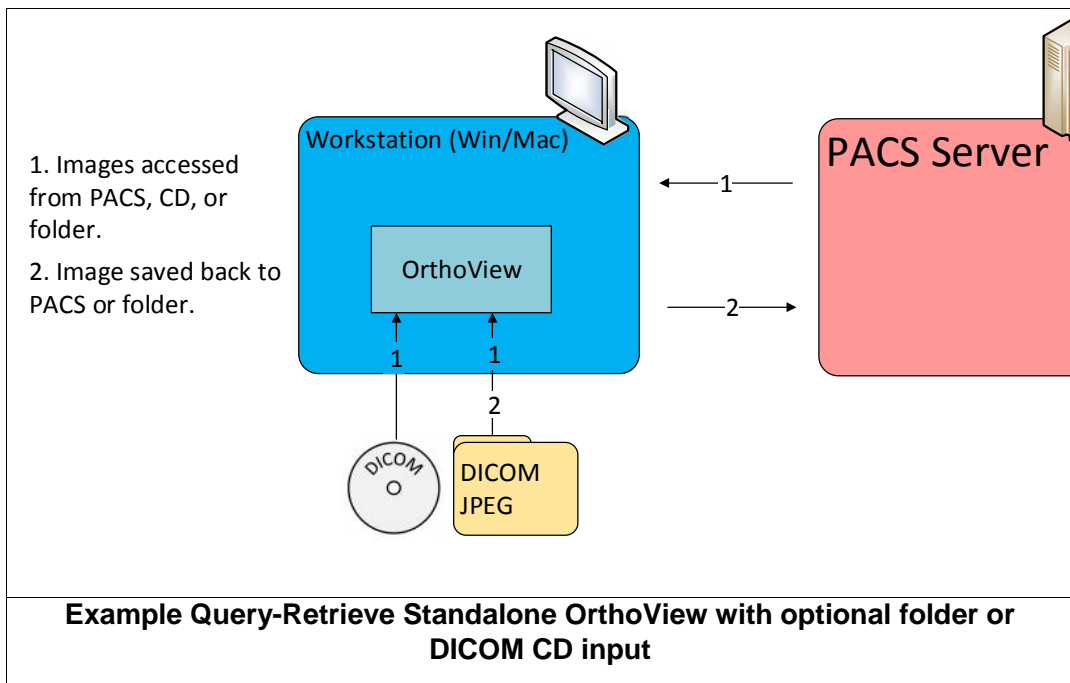

Application Data Flow Diagrams

The Real world activities are shown on the left. These represent user interaction with the system or integrating system. The activities to the right are connecting to DICOM devices outside the scope of this document.

Verify a Remote System SCU

This function is used to check that a DICOM device is available for connection. The C-Echo is sometimes referred to as a "DICOM Ping".

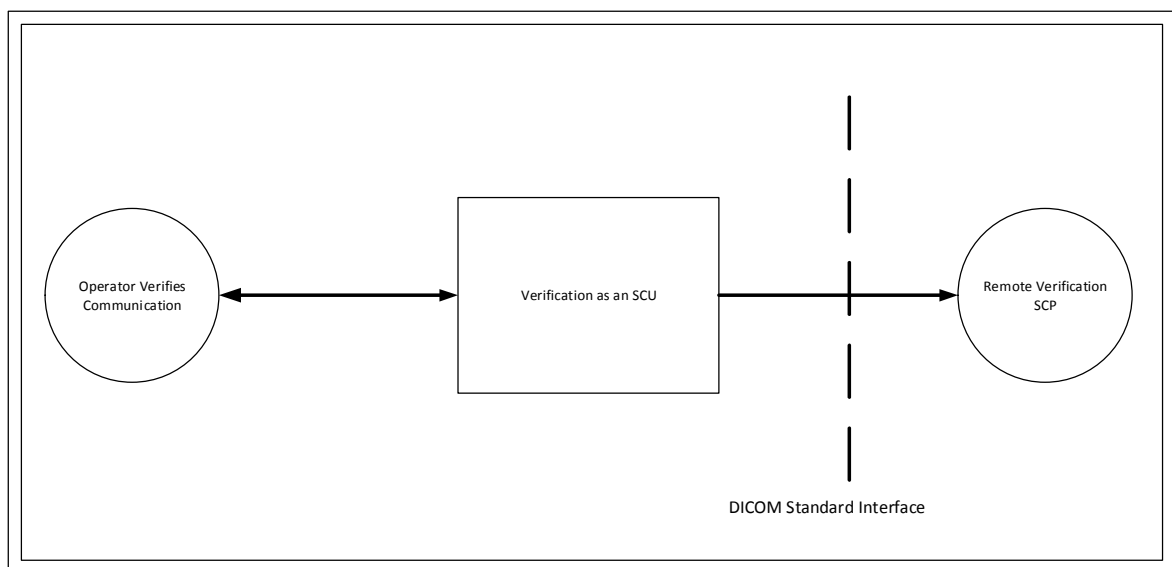

Query/Retrieve SCU

Query and retrieve is used by OrthoView to obtain the set of images required. The query is sometimes performed by the user through a GUI or is passed to OrthoView as a command line argument from an integrating system.

Query-Retrieve can be performed as either a C-MOVE operation or a C-Get Operation depending on the capabilities of the remote node. On a C-Get operation the same association is used for the sending of the files as that of the retrieve request. On a C-Move operation a new association is made.

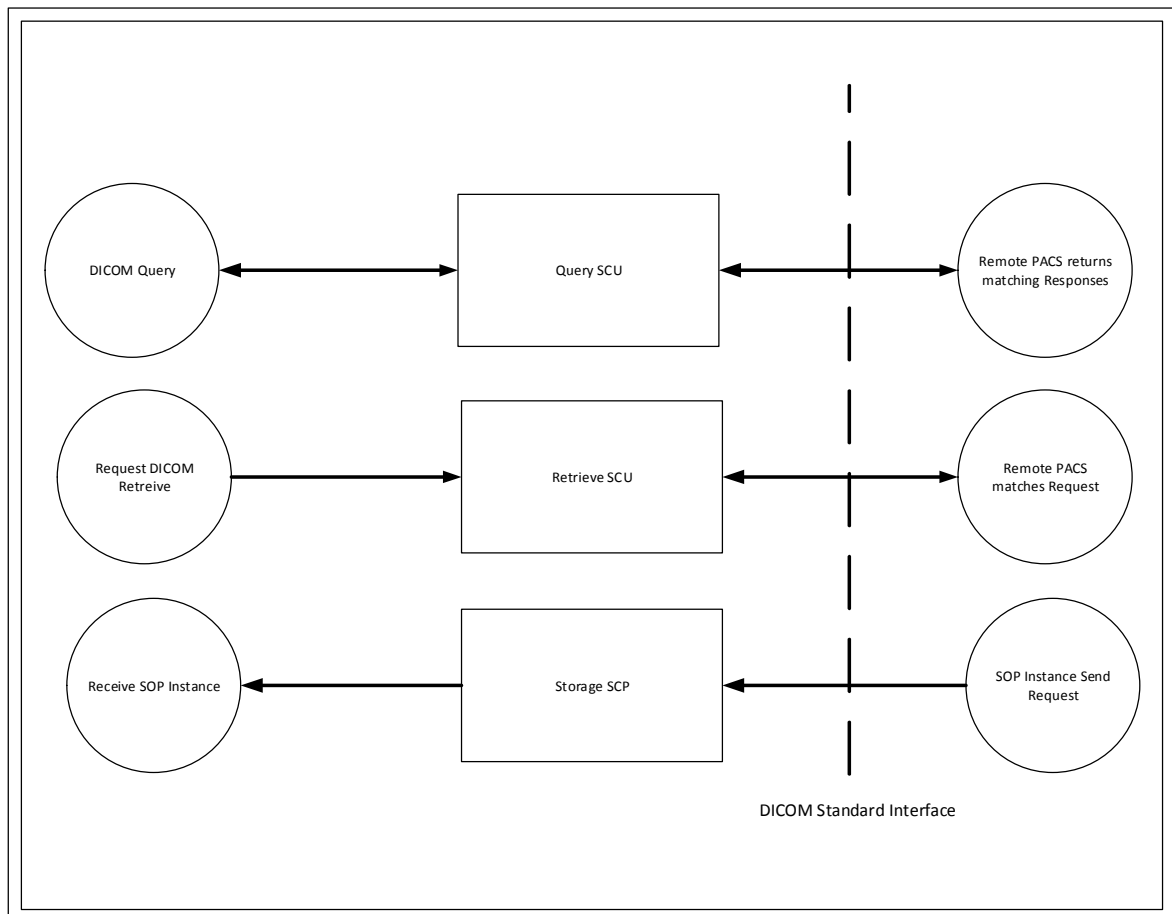

Store SCU

On Output OrthoView can save Secondary Capture files and send them back to the PACS as a C-STORE SCU Operation.

There is a single Secondary Capture file for each planned Image plus another Secondary Capture file with an image of the report. The files are created in a new Series of the same Study as the original images.

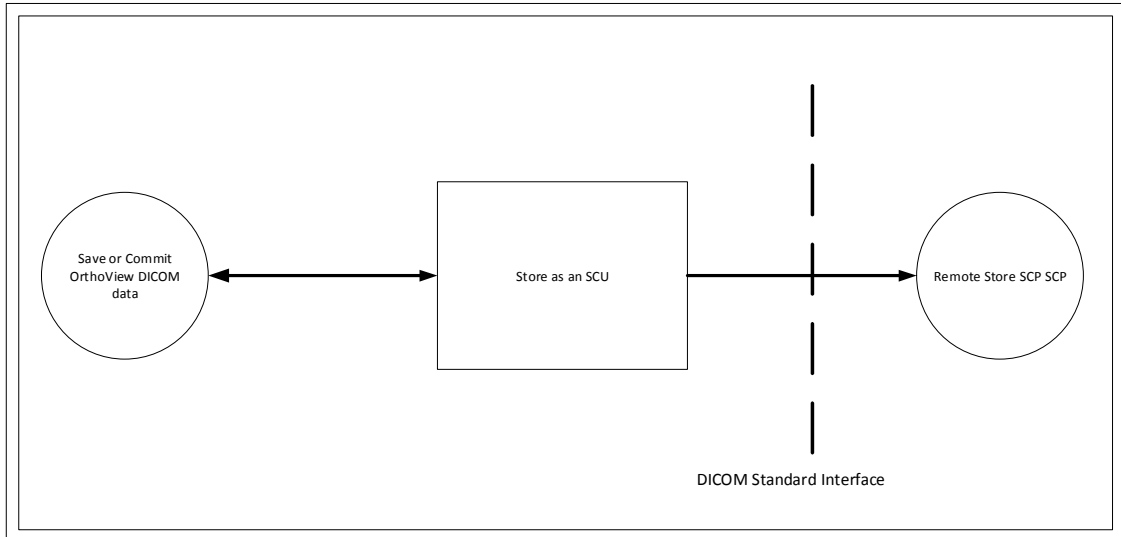

Functional Definition of Application Entities

Separate AETitles can be specified for OrthoView for defining the Local connection for Incoming and Outgoing DICOM operations. The AETitle used does not in itself define the operations that can be performed but merely define the means for DICOM devices to address OrthoView when sending to it or to authorize the connection when receiving from it.

Sequencing of Real World Activities

All Real World activities specified here may occur independently but the transfer of files will always occur sequentially, any data will be queued.

Network Service Specifications

The network services supported by this device are specified in the following table.

OrthoView Network Services			
SOP Class	SOP Name	User Of Service (SCU)	Provider of Service (SCP)
1.2.840.10008.1.1	Verification C-ECHO	YES	NO
1.2.840.10008.5.1.4.1.2.1.1	Patient Root C-FIND	YES	NO
1.2.840.10008.5.1.4.1.2.1.2	Patient Root C-MOVE	YES	NO
1.2.840.10008.5.1.4.1.2.2.1	Study Root C-FIND	YES	NO

1.2.840.10008.5.1.4.1.2.2.2	Study Root C-MOVE	YES	NO
1.2.840.10008.5.1.4.1.2.1.3	Patient Root C-GET	YES	NO
1.2.840.10008.5.1.4.1.2.2.3	Study Root C-GET	YES	NO

Association Establishment Policies

Number of Associations

The number of concurrent associations is configurable but defaults to 25 connections. This number may also be limited by memory restrictions.

Asynchronous Nature

OrthoView does not support asynchronous communication (multiple outstanding transactions over a single association).

Implementation Identifying Information

Association Identifying Information	
SOP Class	SOP Name
Implementation Class UID	1.2.826.0.1.3680043.2.875.0.x.y.z
Implementation Version Name	DEXxyz

Where x.y.z = the DICOM library version number.

Association Initiation Policy

The following events initiate Association creation:-

- The Operator requests Verification of a PACS connection
- The Operator requests Query-Retrieve Operation

Verification C-ECHO

The verification C-ECHO is supported in the SCU role. It is treated as a standalone function to be used in verifying the PACS System or DICOM proxy availability.

Service Object Pair – C-ECHO	
SOP Class	SOP Name
1.2.840.10008.1.1	Verification

Associated Real World Activity

The DICOM Ping (C-Echo) functionality is available as a command from the hosting application. The operation will result in a C-Echo being generated and sent to any connected PACS or proxy. Please note that when passed to a proxy the C-Echo only determines the availability of the proxy and does not guarantee the availability of any connected PACS system.

Proposed Presentation Contexts

OrthoView proposes only the default transfer syntax.

Presentation Context - Syntax	
Proposed Syntax UID	Syntax Name
1.2.840.10008.1.2	Implicit VR Little Endian

Query/Retrieve Composite C-FIND, C-MOVE and C-GET

OrthoView supports both the Patient Query Model and Study Query model as an SCU.

Service Object Pair – C-Find	
SOP Class	SOP Name
1.2.840.10008.5.1.4.1.2.1.1	Patient Root Find
1.2.840.10008.5.1.4.1.2.2.1	Study Root Find
1.2.840.10008.5.1.4.1.2.1.2	Patient Root Move
1.2.840.10008.5.1.4.1.2.2.2	Study Root Move
1.2.840.10008.5.1.4.1.2.1.3	Patient Root Get
1.2.840.10008.5.1.4.1.2.2.3	Study Root Get

Associated Real World Activity

The Query (C-Find) functionality is available as a command from the hosting application. The operation will result in a query being generated and being passed through to the connecting DICOM system. The results of the query will then be displayed to allow selection of the files to be requested.

Both C-Move and C-Get are supported, their real world activities being the same. Selection of C-Move or C-GET is dependent on the capabilities of the connecting PACS. C-Move uses a separate association while C-Get reuses the association. Either method results in DICOM files being transferred from the remote PACS device to the caller.

Proposed Presentation Contexts

Only the default transfer syntax is presented

Presentation Context - Syntax	
Proposed Syntax UID	Syntax Name

Implementation Model

The OrthoView GUI allows for the setting of query filters, display of the query results and some customization of the results.

The actual set of query parameters supported will be determined as the intersecting set of elements supported by the OrthoView and those supported by the connecting PACS. To provide the best possible capability the OrthoView supports as rich a set of attributes as possible.

Query Parameters supported by OrthoView			
Element ID	Name	Level	Support by PACS
(0010,0010)	Patient Name	Patient/Study	Mandatory
(0010,0020)	Patient ID	Patient/Study	Mandatory
(0010,0030)	Patient DOB	Patient/Study	Mandatory
(0010,0040)	Patient Sex	Patient/Study	Mandatory
(0020,000D)	Study UID	Study	Mandatory
(0020,0010)	Study ID	Study	Mandatory
(0008,0020)	Study Date	Study	Optional
(0008,0050)	Accession Number	Study	Mandatory
(0008,0060)	Modality	Study	Optional
(0008,0080)	Institution	Study	Optional
(0032,1060)	Requested Procedure	Study	Optional
(0020,000E)	Series UID	Series	Mandatory
(0008,103E)	Series Description	Series	Mandatory
(0008,0060)	Modality	Series	Mandatory
(0032,1060)	Requested Procedure	Series	Optional
(0018,0015)	Body Part Examined	Series	Optional
(0008,0021)	Series Date	Series	Optional
(0008,0031)	Series Time	Series	Optional
(0008,0018)	Instance UID	Image	Mandatory
(0028,0011)	Image Width	Image	Mandatory
(0028,0010)	Image Height	Image	Mandatory
(0028,0008)	Image Frames	Image	Mandatory

C-Store as an SCP

OrthoView supports receipt of images via C-Store as an SCP.

When retrieving images OrthoView only supports CR/DX and SC images.

OrthoView Network Services			
SOP Class	SOP Name	User Of Service	Provider of

		(SCU)	Service (SCP)
1.2.840.10008.5.1.4.1.1.1	Computed Radiography Image Store	YES	YES
1.2.840.10008.5.1.4.1.1.1.1	Digital X-Ray for Presentation	YES	YES
1.2.840.10008.5.1.4.1.1.7	SC -Secondary Capture Storage	YES	YES

Associated Real World Activity

The Store (C-Store SCP) function is required to receive the images requested for retrieval. The images arrive and are stored on the local workstation.

OrthoView can also receive images as unsolicited C-Moves (if running can be sent images directly by another DICOM device).

CR/DX images are treated as “original” images for planning, while SC images are used for previously planned OrthoView images which can be reloaded.

Original (images not previously created by OrthoView) are stored together into folders by StudyUID. OrthoView images are instead sorted into folders by SeriesUID. This enables original images to be grouped together according to the treatment while OrthoView examinations can be separately viewed or modified.

Proposed Presentation Contexts

OrthoView supports the following Abstract Syntaxes when performing a C-Store as an SCP.

Abstract Syntax UID	Syntax Name
1.2.840.10008.1.2	Implicit Value Representation (VR) Little Endian Byte Order (Default transfer Syntax)
1.2.840.10008.1.2.1	Explicit Value Representation (VR) Little Endian Byte Order
1.2.840.10008.1.2.2	Explicit Value Representation (VR) Big Endian Byte Order
1.2.840.10008.1.2.5	RLE Compression
1.2.840.10008.1.2.4.50	Jpeg Baseline compression encoding the default transfer syntax for lossy
1.2.840.10008.1.2.4.51	JPEG Extended JPEG Coding Type 2 = 8 bit JPEG Coding Type 4 = 12 bit
1.2.840.10008.1.2.4.57	JPEG lossless, Non-Hierarchical
1.2.840.10008.1.2.4.70	JPEG Lossless, Non-Hierarchical, First Order Prediction. The default transfer syntax for lossless JPEG.
1.2.840.10008.1.2.4.90	Lossless (Reversible) mode of JPEG 2000 Part 1 (ISO/IS15444-1)
1.2.840.10008.1.2.4.91	Lossless (Reversible) mode of JPEG 2000 Part 1 (ISO/IS15444-1) or Lossy (Irreversible) mode of JPEG2000 Part 1 (ISO/IS15444-1)

Implementation Model

The C-Store will be generated following the retrieve request from the user or integrating system.

C-Store as an SCU

OrthoView generates Secondary Capture images based on the original CR or DX images. It generates one secondary capture image for each planned image plus a single secondary capture image representing the report as an image.

OrthoView Network Services			
SOP Class	SOP Name	User Of Service (SCU)	Provider of Service (SCP)
1.2.840.10008.5.1.4.1.1.7	SC -Secondary Capture Storage	YES	YES

Associated Real World Activity

The Store (C-Store SCU) function is required to store the OrthoView output back into the PACS system.

Proposed Presentation Contexts

OrthoView supports the following Abstract Syntaxes when performing a C-Store as an SCU.

Abstract Syntax UID	Syntax Name
1.2.840.10008.1.2	Implicit Value Representation (VR) Little Endian Byte Order (Default transfer Syntax)
1.2.840.10008.1.2.1	Explicit Value Representation (VR) Little Endian Byte Order
1.2.840.10008.1.2.2	Explicit Value Representation (VR) Big Endian Byte Order
1.2.840.10008.1.2.5	RLE Compression
1.2.840.10008.1.2.4.50	Jpeg Baseline compression encoding the default transfer syntax for lossy
1.2.840.10008.1.2.4.51	JPEG Extended JPEG Coding Type 2 = 8 bit JPEG Coding Type 4 = 12 bit
1.2.840.10008.1.2.4.57	JPEG lossless, Non-Hierarchical
1.2.840.10008.1.2.4.70	JPEG Lossless, Non-Hierarchical, First Order Prediction. The default transfer syntax for lossless JPEG.
1.2.840.10008.1.2.4.90	Lossless (Reversible) mode of JPEG 2000 Part 1 (ISO/IS15444-1)
1.2.840.10008.1.2.4.91	Lossless (Reversible) mode of JPEG 2000 Part 1 (ISO/IS15444-1) or Lossy (Irreversible) mode of JPEG2000 Part 1 (ISO/IS15444-1)

Implementation Model

The C-Store will be generated following user performing a save or commit operation.

Communication Profiles

Supported Communication Stacks

The OrthoView provides DICOM V3.0 TCP/IP Network Communication Support as defined in Part 8 of the DICOM standard.

TCP/IP Stack

This application inherits its TCP/IP stack from the platform on which it executes.

Physical Media Support

Ethernet ISO 8802-3 Standard AUI, optional twisted pair 10-Base-T

Extensions/Specializations/Privatizations

There are no extensions or specializations to the standard SOP classes. There are no special uses of private tags.

Configuration

OrthoView has a number of preferences to allow configuration of its DICOM communications. These settings can be found under the "DICOM Network" tab of the preferences dialog.

Remote Connections

OrthoView allows the definition of multiple DICOM connections. Each connection has:-

Type – Type of connection can be “Query Only”, “Store Only” or “Query and Store”.

Name – a name used for display and reference purposes only

AETitle – Application Entity Title of the remote device

Port – Port on which remote device located

IP Address – Address on which remote device located

Incoming Settings (where incoming supported)

Incoming settings apply only to C-Store as an SCP

Accept Incoming Files (Yes/No) – This option enables/disables unsolicited C-Moves

Local AE – The AETitle for remote devices to use when addressing this device.

Query Settings (where query-retrieve supported)

Query-Settings only apply to C-Find and C-GET/C-Move

Local AE – The AETitle for remote devices to use when addressing this device.

Query Connection – The name of the pre-setup remote connection to use for communication.

Query-Filter-Fields – The set of fields to be displayed as query filters on the query-retrieve dialog.

Query Model – Study Root or Patient Root

Name Wildcarding – The method to use for positioning of name delimiters when filtering by patient name.

DICOM Retrieve Command – use C-Move or C-Get

Timeout (seconds) – How long to wait for a reply to a transmission before assuming connection lost.

Outgoing Settings

Outgoing settings apply only to C-Store as an SCU

Local AE – The AETitle for remote devices to use when addressing this device.

Outgoing Connection - The name of the pre-setup remote connection to use for communication.

Support of Extended Character Sets

The following Character sets are supported:-

Supported Character Sets	
Supported Language	ISO Designation
LATIN_1	ISO_IR 100
LATIN_2	ISO_IR 101
LATIN_3	ISO_IR 109
LATIN_4	ISO_IR 110
LATIN_5	ISO_IR 148
CYRILLIC	ISO_IR 144
ARABIC	ISO_IR 127
GREEK	ISO_IR 126
HEBREW	ISO_IR 138

THAI	ISO_IR 166
KOREAN	ISO_IR 2022KR
JAPANESE	ISO_IR 2022JP
JAPANESE_KATAKANA	ISO 2022JP IR 13
SIMPLIFIED_CHINESE	GB18030
UNICODE	ISO_IR 192
ASCII	ISO_IR 6
DCM_KANJI	ISO-IR 87
DCM_KANJI_SUP	ISO-IR 159